

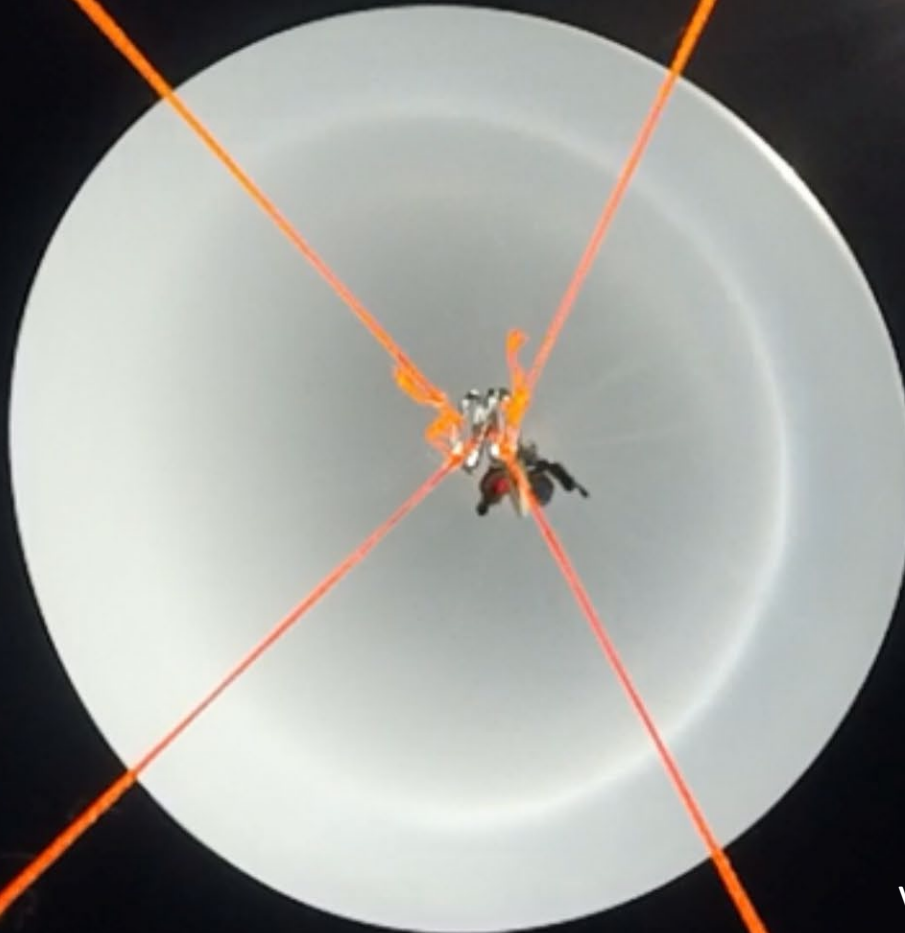

ST. CATHERINE
UNIVERSITY

Balloon borne
stratospheric
night-time and
day-time
thermal wake
differential
temperature
measurements



Presenters:
Alisha Wiedmeier,
Ngozi Ezenagu,
Erick Agrimson

Collaborators:
Rachel DuBose
Brittany Craig
Alynie Xiong
Grace Maki
Ana Taylor
Rachel Lang
Peace Sinyigaya
Viviana Montenegro –
Cortez
Vina Onyango-Robshaw
Kaye Smith
James Flaten
Gordon McIntosh

UNIVERSITY OF MINNESOTA
MORRIS



Abstract

- We present summer 2018 results related to stratospheric temperature measurements collected using a 3.5m “wake boom” structure, which we have used to characterize the magnitude and extent of the thermal wake below an ascending high altitude balloon. The “wake boom” structure uses over 20 calibrated temperature sensors set at intervals along a horizontal carbon fiber rod. Summer 2018 data confirms thermal wake profile data taken in 2016 during a night flight, as well as daytime temperature profiles collected during the summer of 2017. To present how the thermal wake grows as our balloons ascend through the stratosphere, we compared the average temperature of the ten central temperature sensors to the average of the four outermost sensors on the wake structure. This method clearly shows a daytime wake that warms in the center as the balloon ascends and a night time wake that cools in the center during ascent, as predicted by Tiefenau et al. ⁽¹⁾ Using this method we also present data from the August 21st, 2017, total solar eclipse, which show a unique wake profile, an “eclipse” thermal wake.
- (1) Tiefenau, H. and Gebbeken, A. *Influence of meteorological balloons on Temperature Measurements with Radiosondes: Nighttime Cooling and Daylight Heating*, J. Atmos. and Oceanic Tech. 6 (36-42), 1989.

Theory – Thermal Wake Effect

Symmetrical and Asymmetrical temperature wake profiles beneath balloons during Day and Night ascents. Blue is representative of the adiabatic cooling of the He gas which is always present but is dwarfed by solar radiation heating during the day.

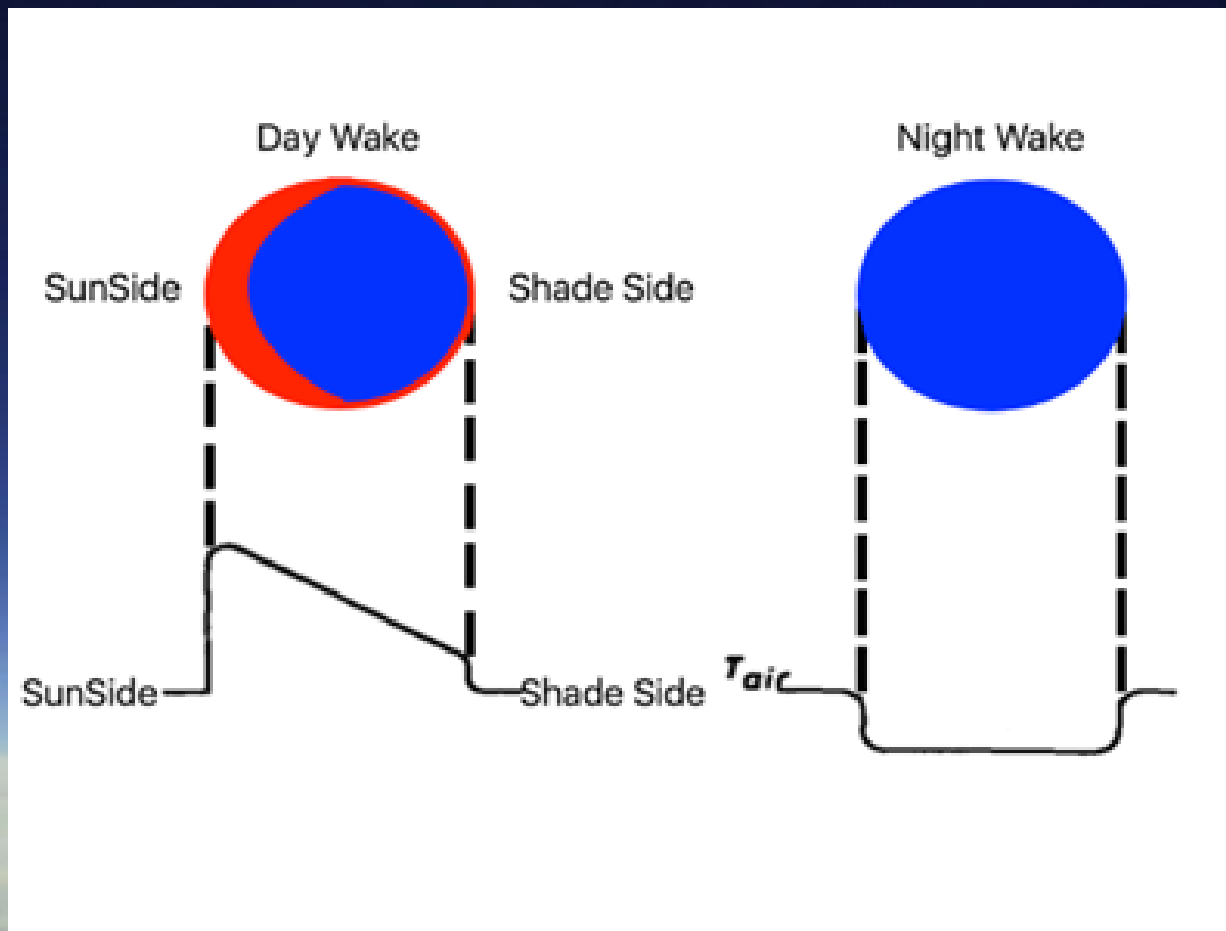



Balloon



Pictures by: Peace Sinyigaya

Wake boom

- We measure the spatial temperature effect using a “wake boom.”
- Built from carbon fiber tubing, 3.5m total width.
- 11 digital band-gap sensors mounted from the center to each side of the wake boom for a total of 22 sensors, plus 6 to 8 thermistors.
- Prior to flight, all sensors are calibrated to a NIST certified thermocouple using a low pressure, low temperature chamber. The calibration reduces sensor to sensor variability which becomes more significant at low temperatures and pressures.

Anatomy of a Wake Boom

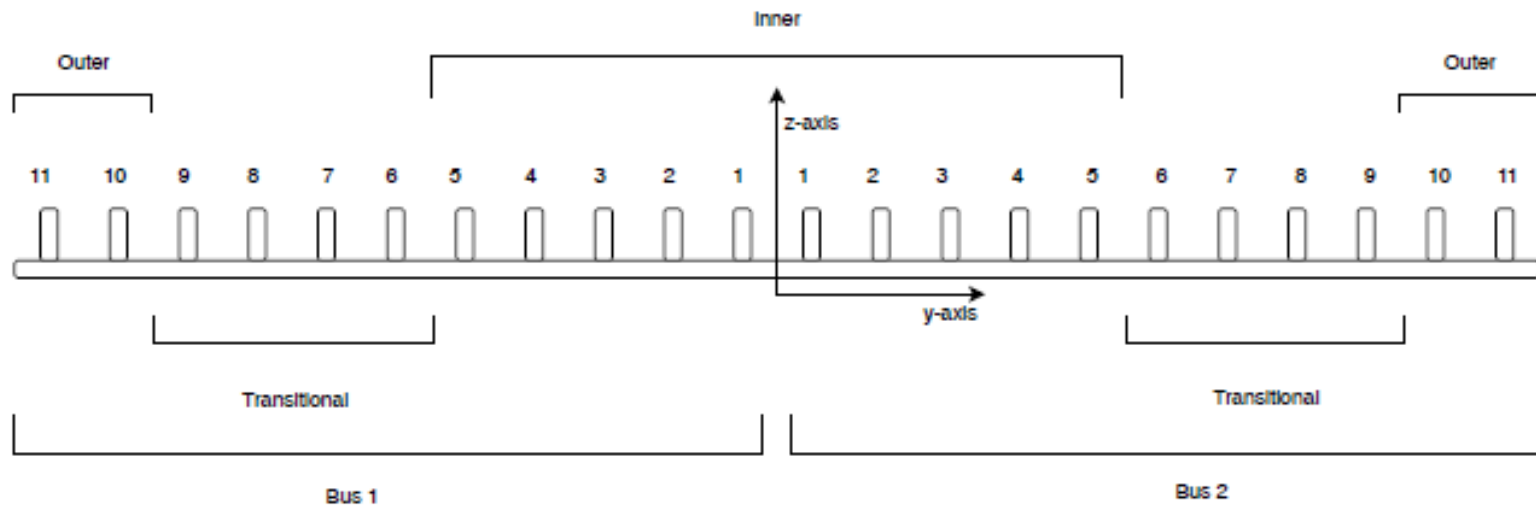

$$\Delta T = \bar{x}_{\text{inner}} - \bar{x}_{\text{outer}}$$

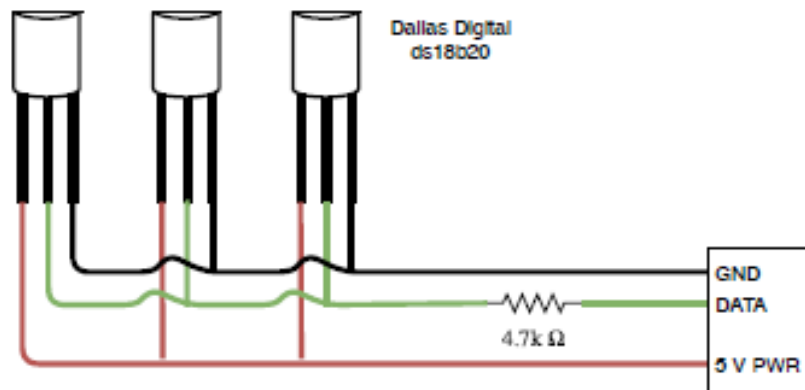

Experiments

- Balloon launched previously to characterize the nighttime wake (8-4-16 and 7-22-18)
- Six balloons carrying wake booms were launched within the 48 hour window leading up to and including the solar eclipse event.
- All flights launched between 11:30 CDT and 12:30 CDT to reduce diurnal temperature effects.
- Follow up daytime launch 6-13-18



Cross sectional area of the balloon wake and the thermal wake plotted against altitude for an ascending HAB. Calculations are based on standard atmospheric conditions using a 1600 g balloon with helium as the lifting gas. Actual balloon size was measured from video footage taken during an eclipse day ascent using an upward-pointing camera

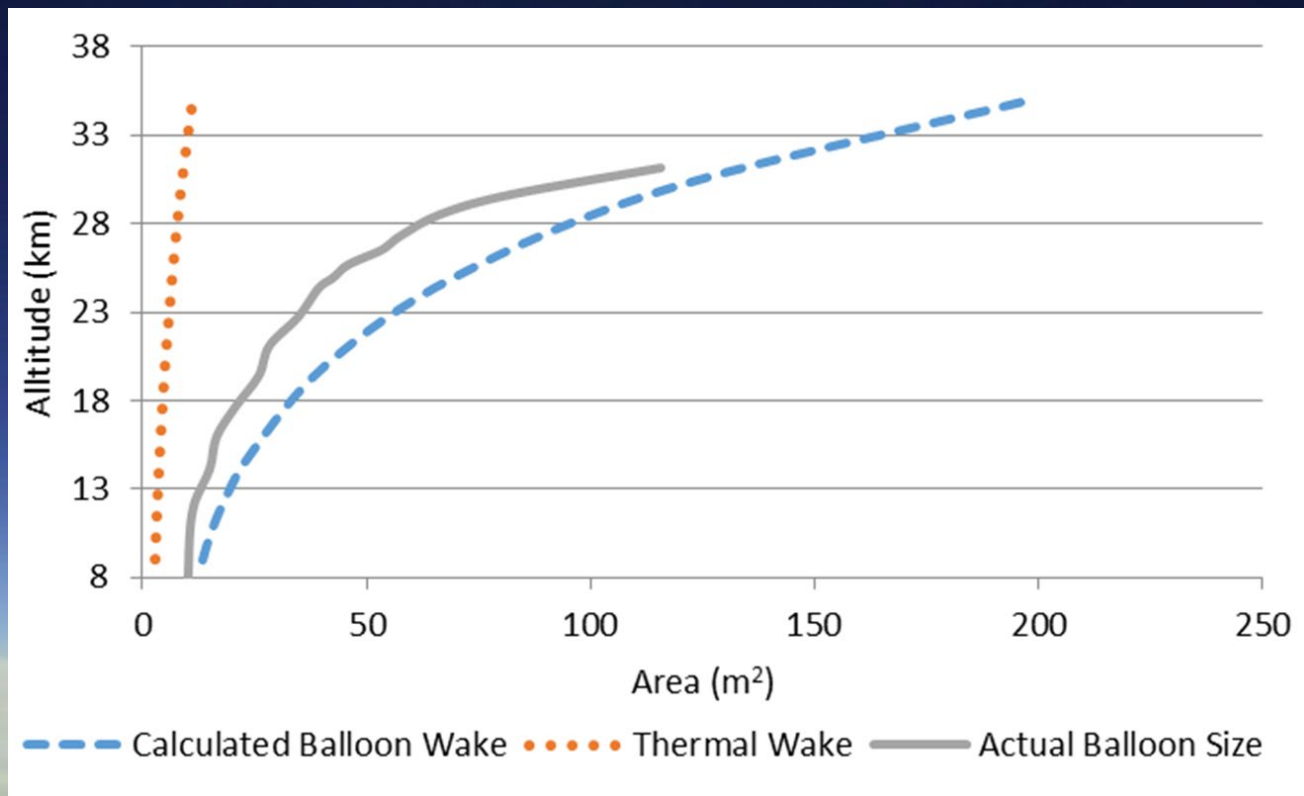

Eclipse Flights

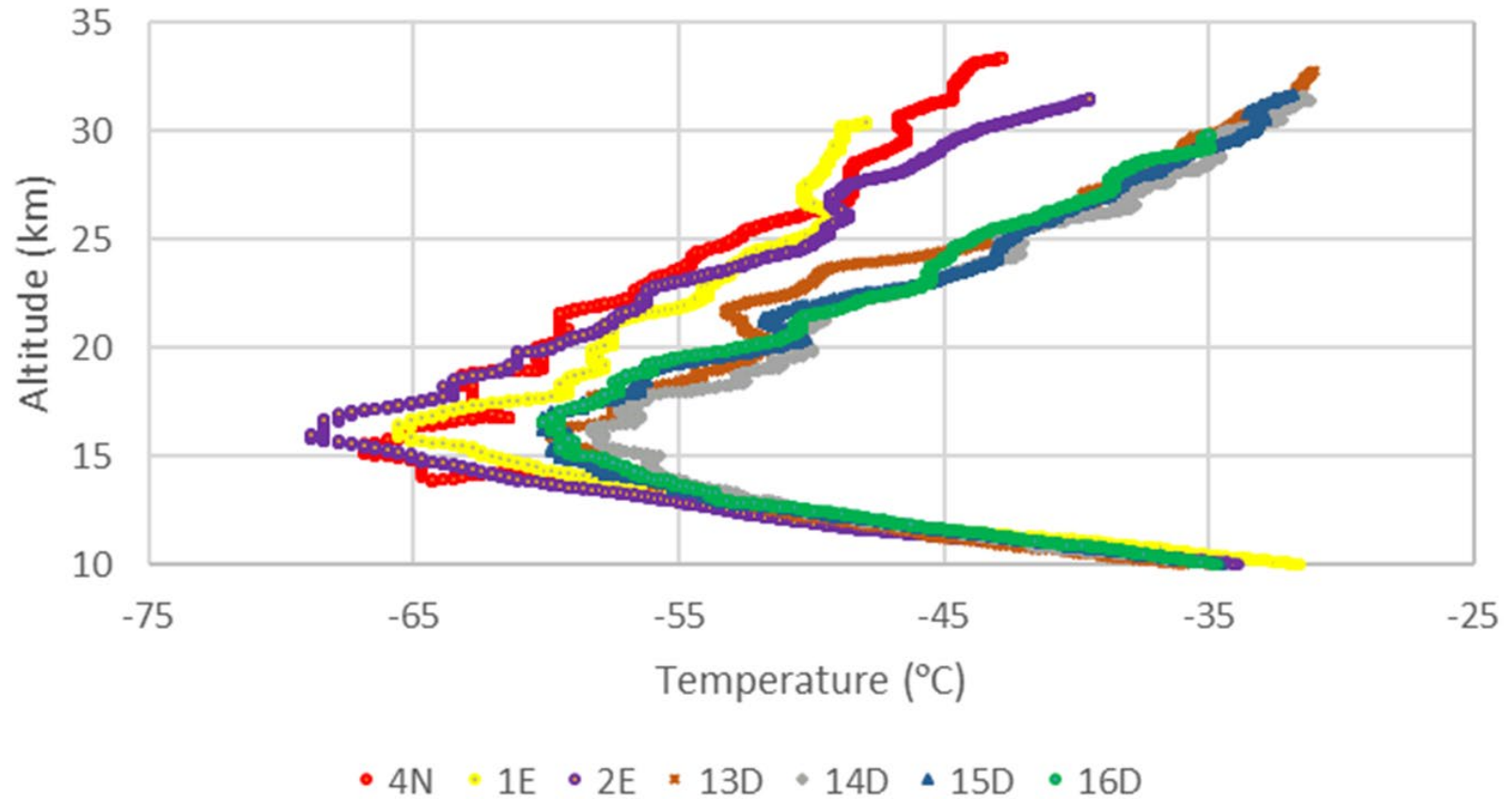

4N showing a negative temperature difference between the average temperature measured across the central 100 cm of the wake boom and the average temperature measured by the outermost sensors. The negative difference indicates that it is cooler within the thermal wake directly beneath the balloon.

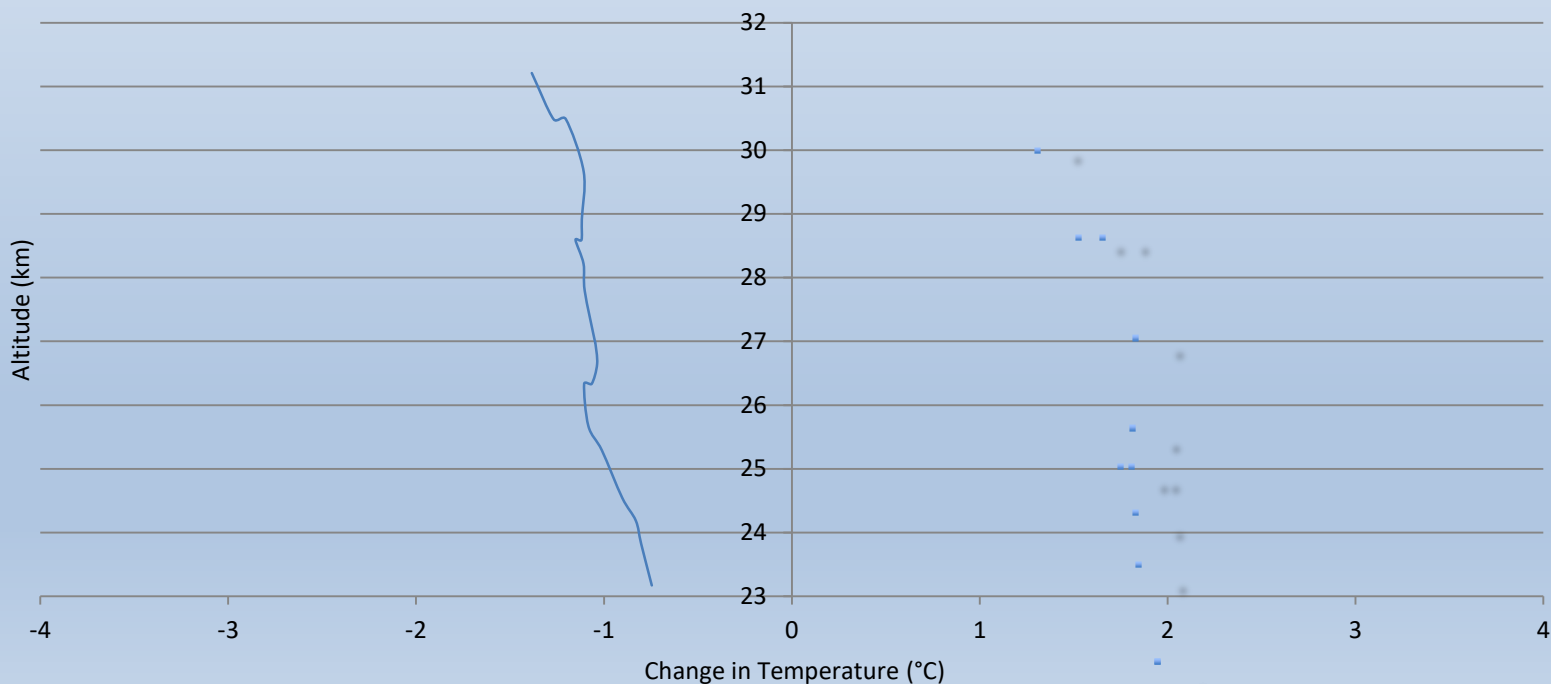

Old way 4N “Slices”

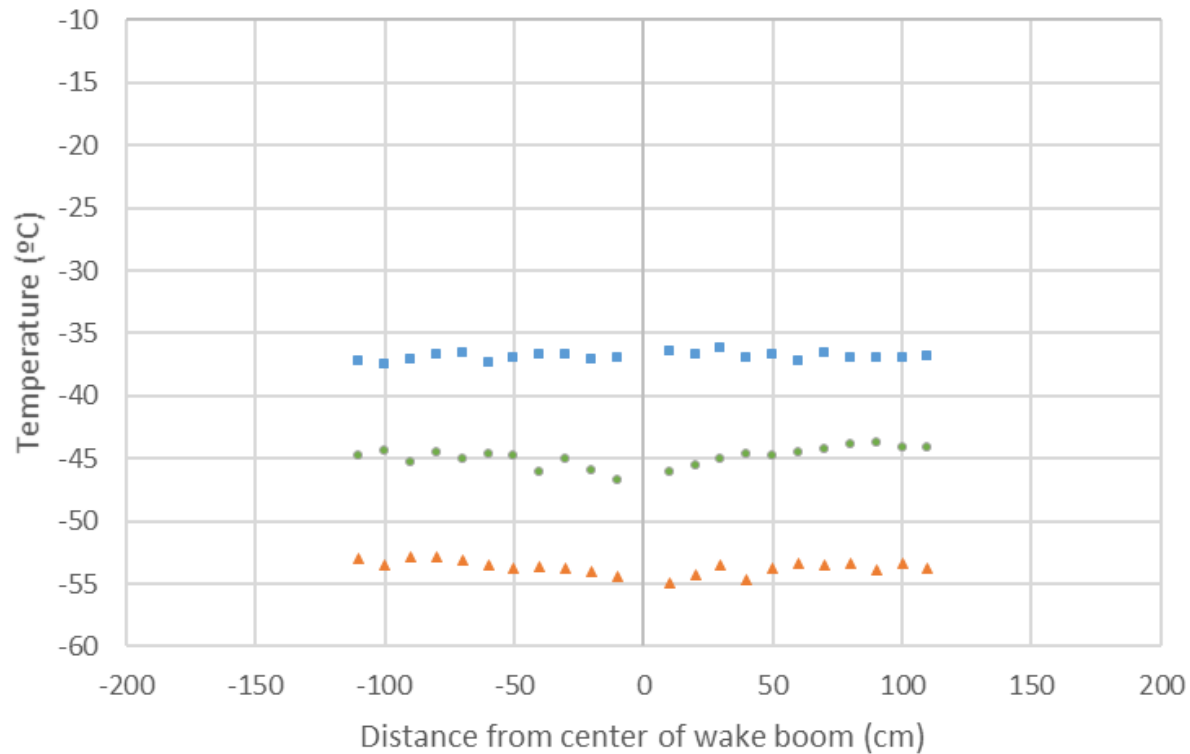

■ Troposphere

▲ Low-stratosphere

● Mid-stratosphere

Night Flight 5N

Difference Night Flight 7/22/18

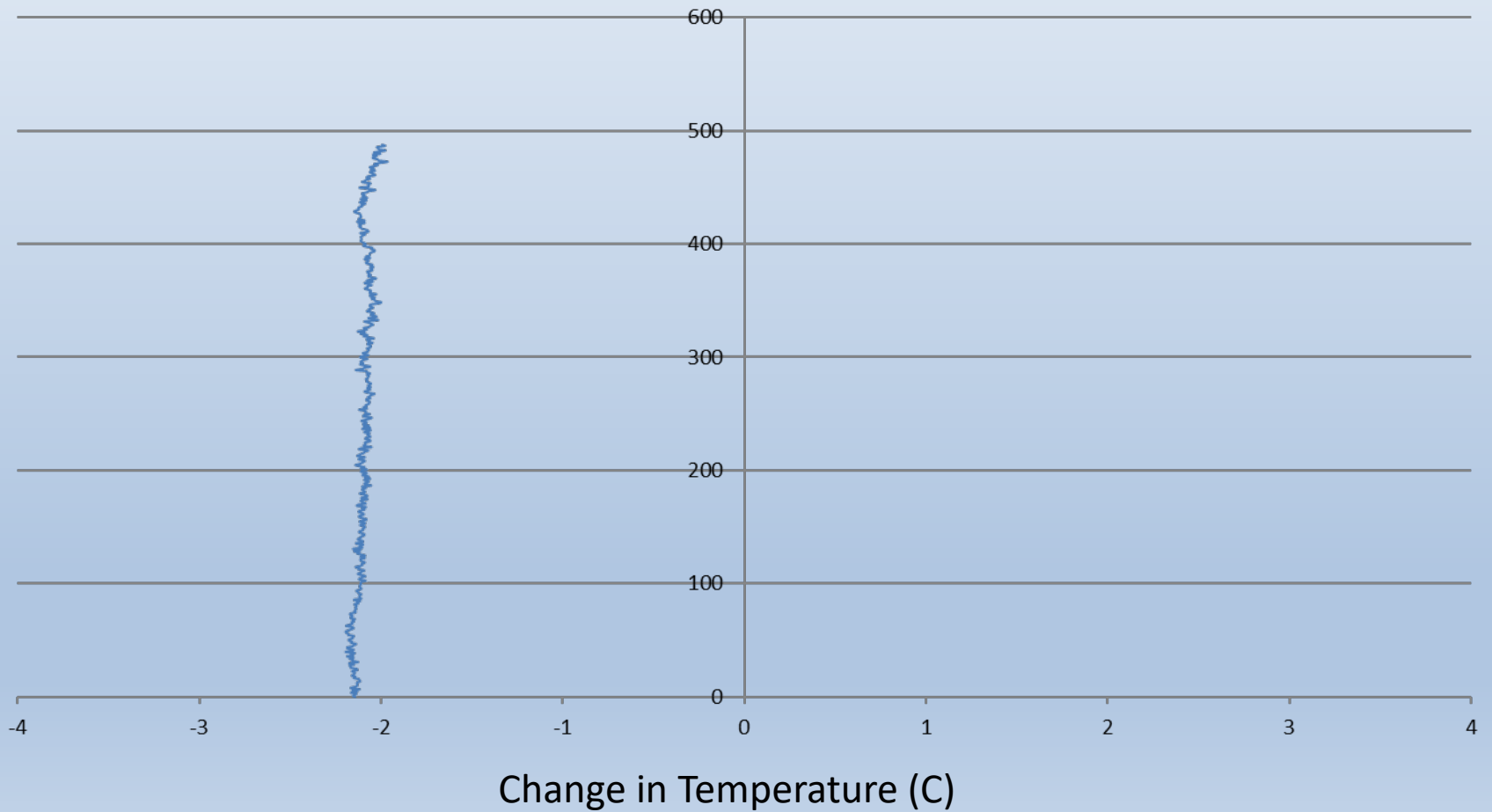

16D The positive difference indicates that it is warmer beneath the balloon. This increasing positive result agrees with Tiefenau [2], that warm wake effects increase as the heat exchange layer thickness grows with decreasing pressure.

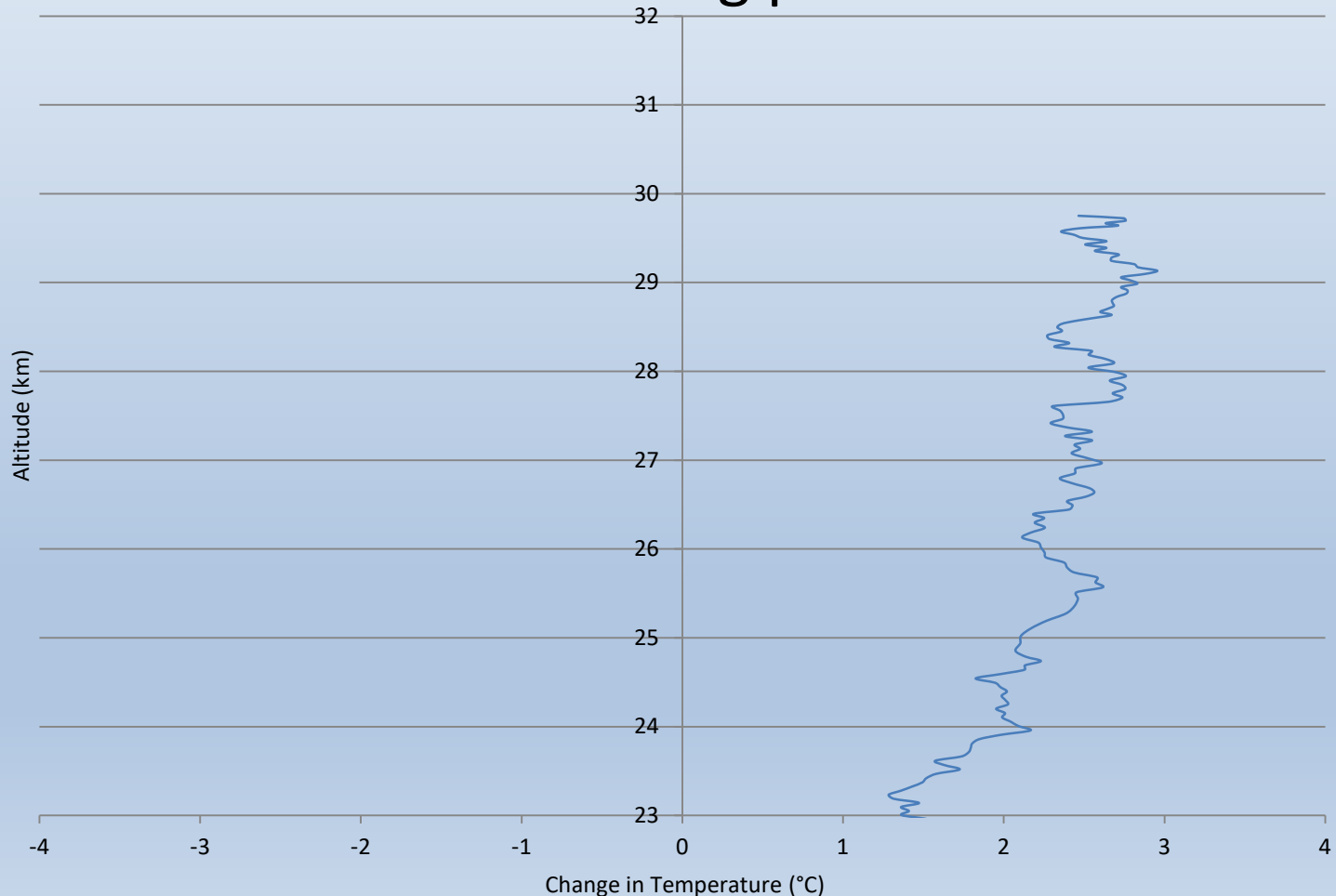

Old Way 16 D "Slices"

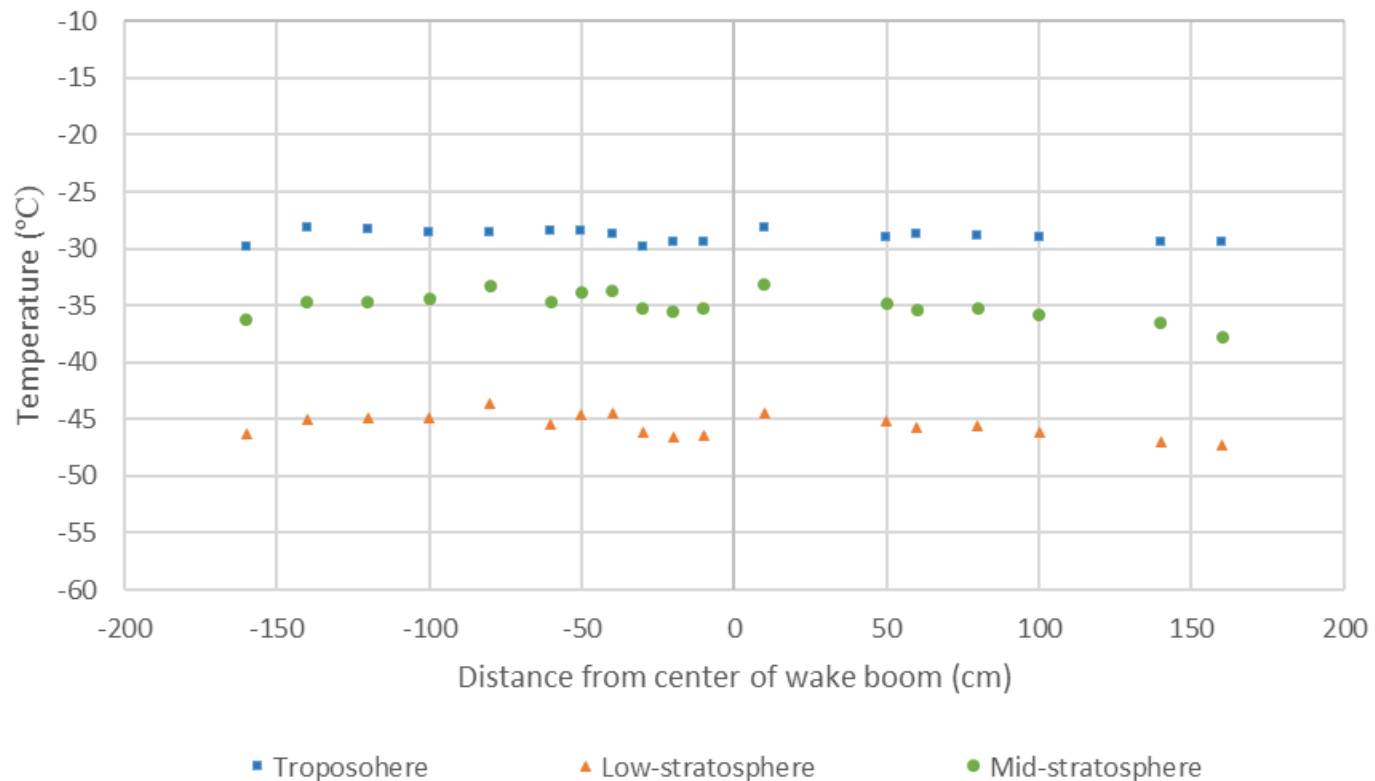

Day Flight D17

Difference Day Flight 6/13/2018

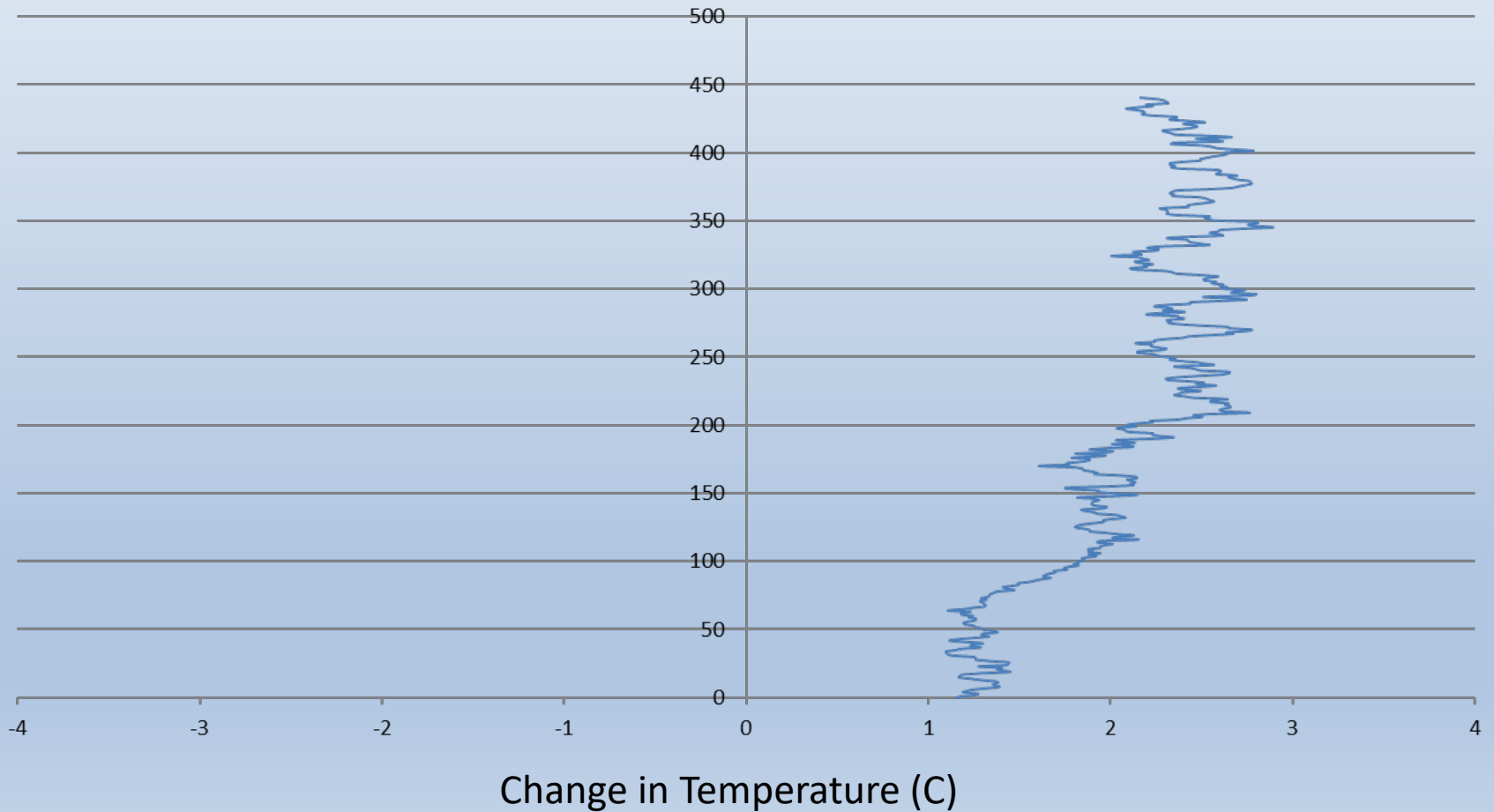

Eclipse flights in relation to path of totality (12:59 pm start)

Northern Eclipse Zone with Balloon Flight Paths

Legend

Flight 1E Totality

Flight 2E Totality

Lincoln

Hastings

Grand Island

Google Earth

© 2017 Google
Image Landsat / Copernicus

20 mi

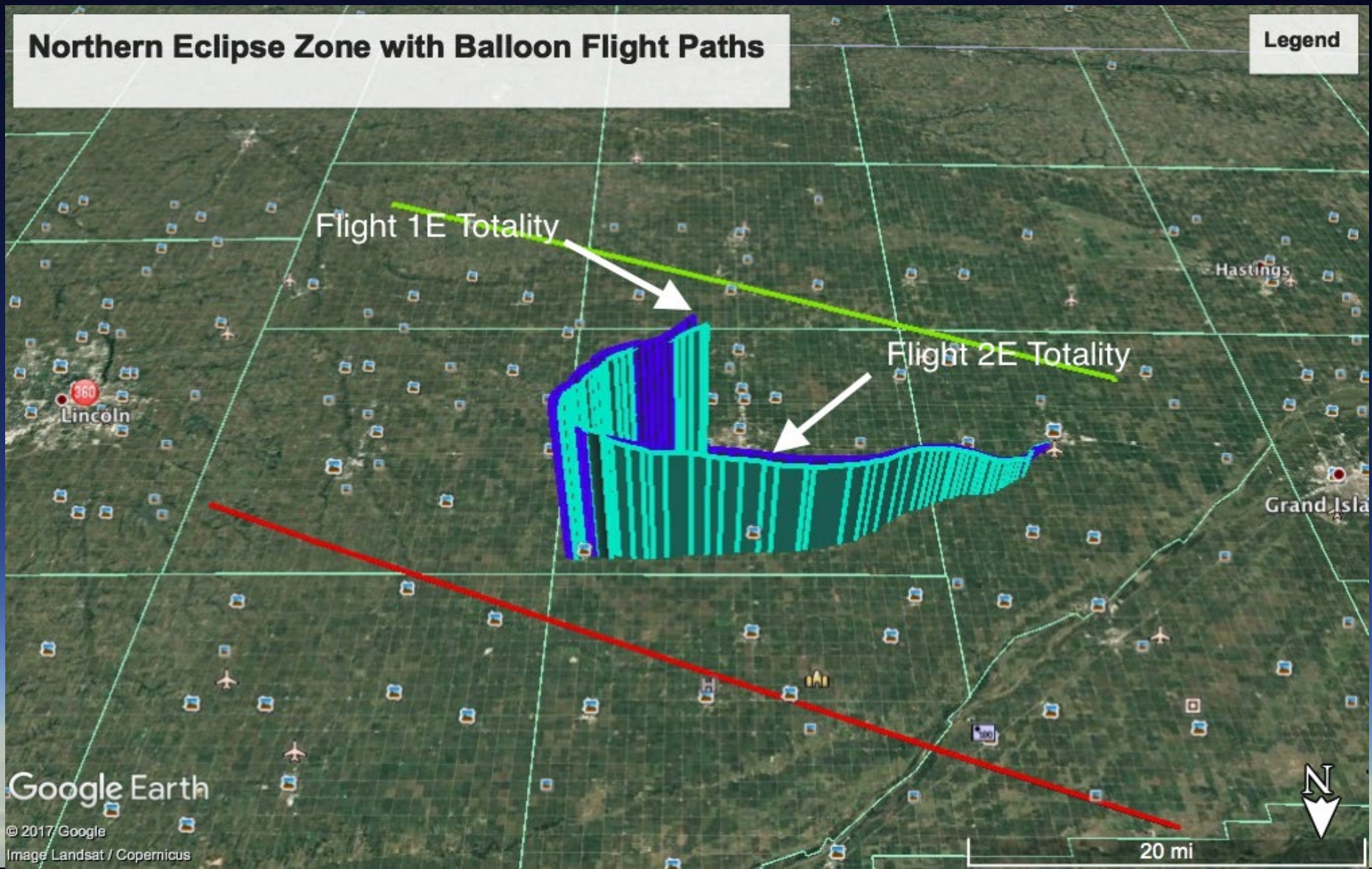

1E Compared to the night and day flights, the temperature difference across the wake boom is nearly constant, indicating no significant positive or negative temperature difference across the thermal wake profile.

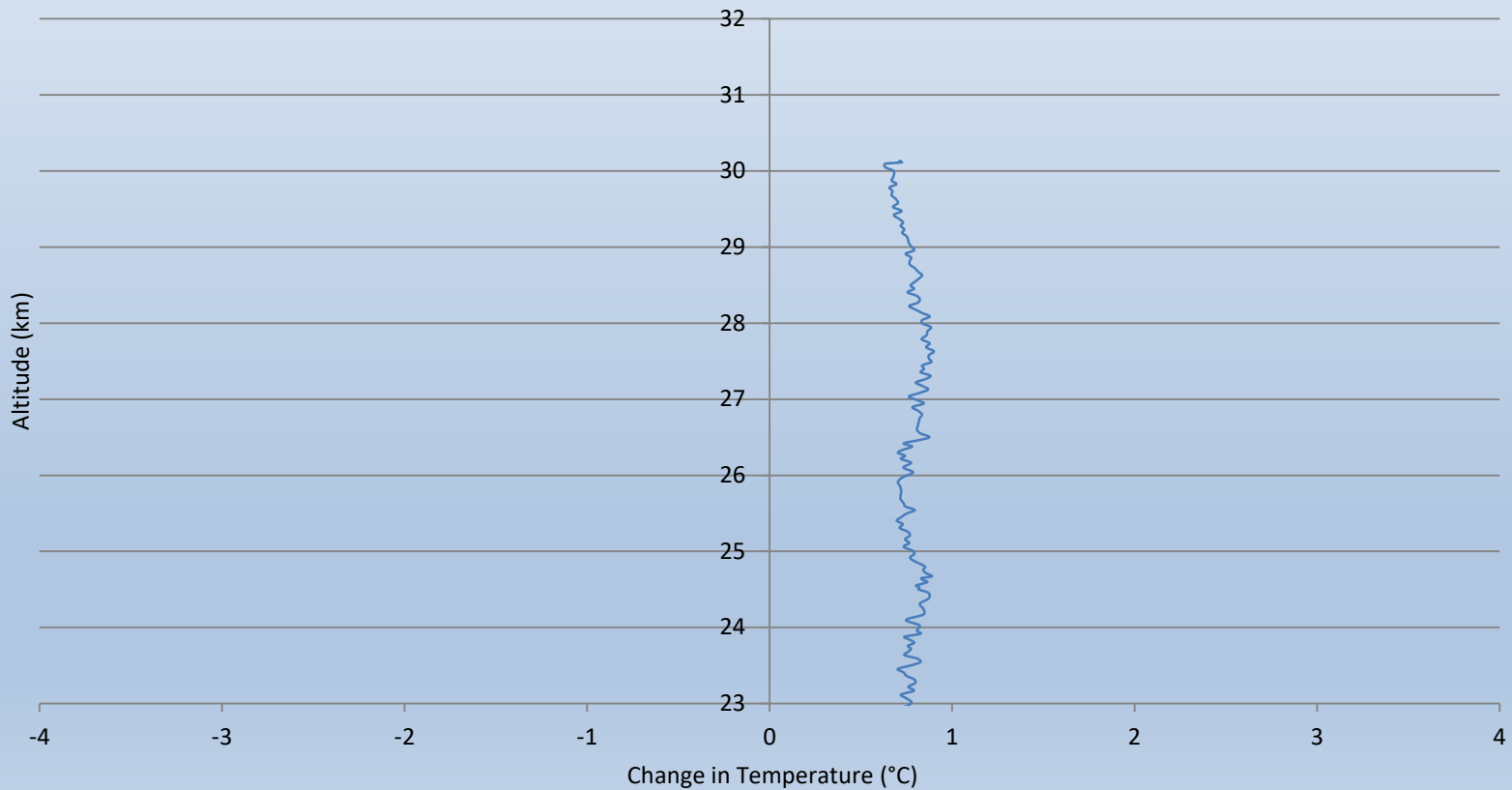

2E stratospheric temperature difference showing that wake boom profiles were essentially zero well past totality. A slight warming begins at 26 km altitude, approximately 25 minutes after totality.

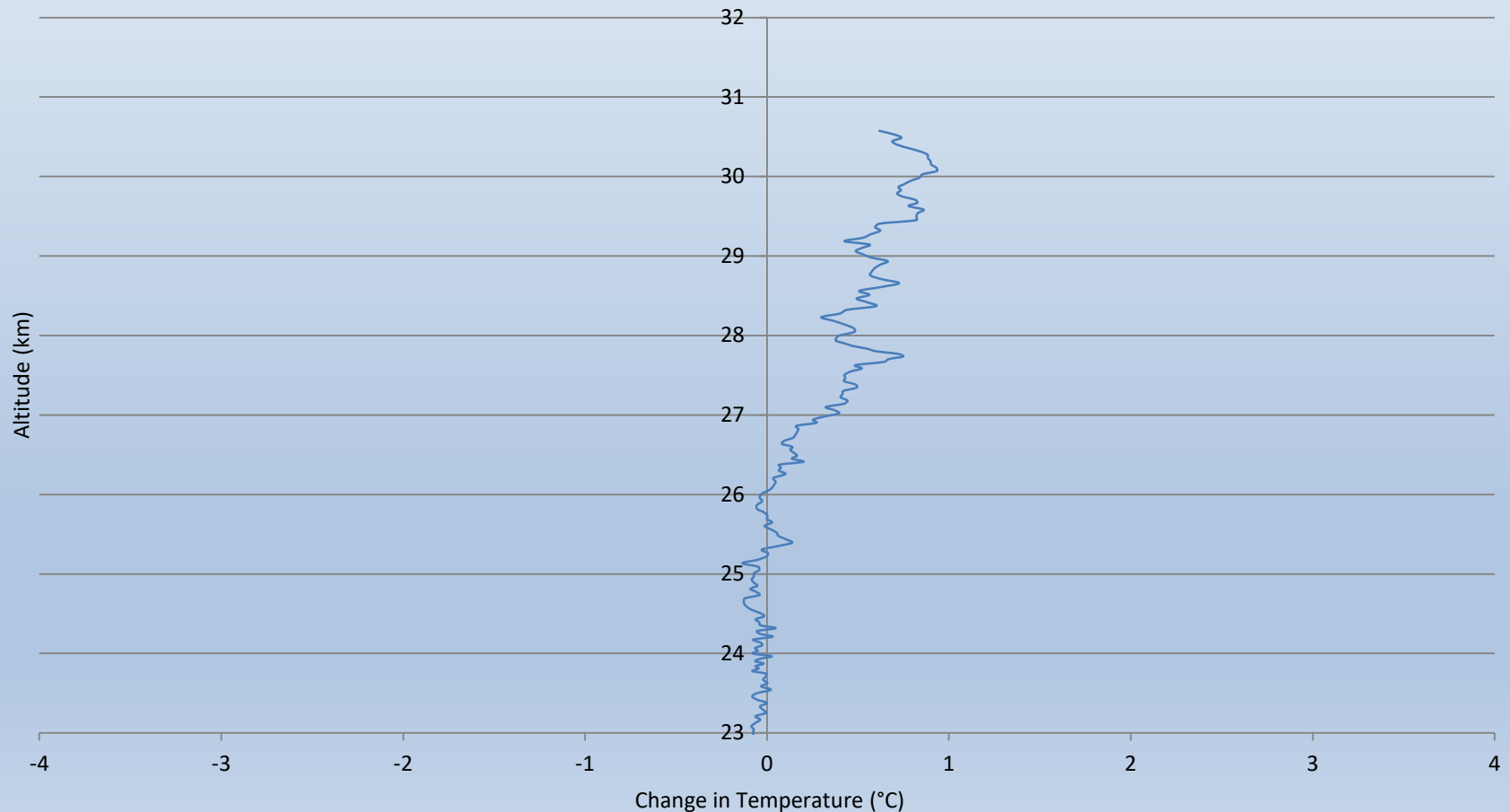

Acknowledgments

- Faculty Advisors

- Erick Agrimson St.CU
- Kaye Smith St.CU
- James Flaten U of M, Twin Cities
- Gordon McIntosh U of M, Morris

- St. Catherine Aerospace Team Summer 2017 and 2018

- Alynie Xiong
- Grace Maki
- Peace Sinyigaya
- Vina Onyango-Robshaw
- Ana Taylor
- Rachel Lang
- Viviana Montenegro Cortez
- Ngozi Ezenagu
- Alisha Wiedmeier

General Dynamics

Brittany Craig – St. CU Alumna

Skywater Technology Foundry

Rachel DuBose – St. CU Alumna

Financial Support

Minnesota Space Grant Consortium

Carol Easley Denny

St.CU Summer Scholars Program

Assist. Mentoring Program St.CU

St. CU APDC funds

UMM Academic Partnerships

UMM Research Enhancement

Funds

References

- 1. Dutta, G., Jushi, M., Pandarinath, N., Bapiraju, B., Srinivasan, S., Subba Rao J., and H. Aleem Basha. Wind and Temperature over Hyderabad during the solar eclipse of 24 Oct. 1995. Indian Journal of Radio and Space Physics 28 Feb 1999.
- 2. Tiefenau, H. and Gebbeken, A. Influence of meteorological balloons on Temperature Measurements with Radiosondes: Nighttime Cooling and Daylight Heating, J. Atmos. and Oceanic Tech. 6 (36-42), 1989.
- 3. Ramkumar, T., Ghosh, P., Reddy, K., Kumar, K., Kumar, S., Reddy, A., Reddy, M. and Prasad, S. Large scale anomalous temperature and wind variations in the lower and middle atmospheres during the solar eclipse of 15 January 2010, Indian Journal of Radio & Space Physics, 43(75-82), 2014

Questions?

